



**2000 A AC/DC Clamp Meter.
True RMS + Multimeter + Direct
current input (mA, μ A)**

ACM-2103 User's Manuals



Caution Symbol

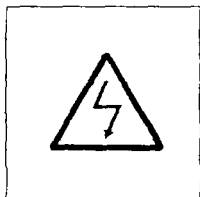

Caution :

- * Risk of electric shock !



Caution :

- * Do not apply the overload voltage, current to the input terminal !
- * Remove test leads before open the battery cover !
- * Cleaning – Only use the dry cloth to clean the plastic case !

Environment Conditions

- * Installation categories III .
- * Pollution Degree 2.
- * Altitude up to 2000 meters.
- * Relative humidity 80% max.

TABLE OF CONTENTS

1. FEATURES.....	1
2. SPECIFICATIONS.....	1
2-1 General Specifications.....	1
2-2 Electrical Specifications.....	2
3. FRONT PANEL DESCRIPTION.....	4
4. PRECAUTIONS & PREPARATIONS FOR MEASUREMENT.....	5
5. MEASURING PROCEDURE.....	6
5-1 Symbols & Units of Display	6
5-2 DCV, ACV Measurement	7
5-3 Resistance Measurement.....	7
5-4 Continuity Check	7
5-5 Diode Test	8
5-6 AC Current Measurement (Clamp on).....	9
5-7 DC Current Measurement (Clamp on).....	9
5-8 AC Current Measurement (Direct input)	10
5-9 DC Current Measurement (Direct input)	10
5-10 Capacitance Measurement.....	11
5-11 Frequency Measurement.....	11
5-12 Duty Cycle Measurement.....	12
5-13 Data Hold Operation.....	12
5-14 Relative Operation.....	12
5-15 Back Light Operation.....	12
6. MAINTENANCE.....	13
6-1 Replacement of Battery.....	13
6-2 Replacement of Fuse.....	13
7. OPTIONAL ACCESSORIES & ADAPTERS	14
8. THE ADDRESS OF AFTER SERVICE CENTER.....	15

1. FEATURES

- * 2 in 1, 2000 A clamp meter + Digital multimeter.
- * Design meet IEC 1010 CATIII 1000V safety requirement.
- * True rms reading for ACV & ACA measurement.
- * 4000 counts, Auto range, multi-functions for ACA, DCA, ACV, DCV, Ohms, Capacitance, Hz, Duty cycle, diode and continuity check.
- * Wide ranges (2000A, 400 A) clamp on current measurement both for ACA & DCA.
- * 4 ranges (400 uA, 4000 uA, 40 mA, 400 mA) direct current input measurement both for ACA & DCA.
- * LSI circuit provides high reliability and durability.
- * Overload protection circuit is provided for all ranges.
- * Data hold, Relative key, Back light.
- * Compact & heavy duty ABS and fireproof plastic case.



2. SPECIFICATIONS



2-1 General Specifications

Display	15 mm (0.6") LCD, 4 digits, Max. indication 5000.
Measurement Range	ACA, DCA, ACV, DCV, Ohms, Diode, Hz, Capacitance, Duty cycle, Continuity beeper.
Polarity	Automatic Switching, "-" indicates negative polarity.
Current Sensor	Hall effect sensor.
Zero adjustment	DCA : Push bottom adjustment. Other ranges : Automatic adjustment.
Over-input	Indication of "1" or "-1".
Sampling Time	Approx. 0.35 second.
Battery	DC 9V battery, heavy duty or Alkaline type, 006P, MN1604 (PP3) or equivalent.
Power Consump.	Approx. DC 5 mA.

Operating Temp.	0 °C to 50 °C (32 °F to 122 °F).
Operating Humidity	Less than 80% RH.
Weight	380 g/0.85 LB (including battery).
Dimension	HWD : 255 x 73 x 38 mm. (10 x 2.9 x 1.5 inch)
Max. Jaw Open Size	60 mm (2.36 inch) Dia.
Accessories Included	Operation manual.....1 PC Test lead (red & black).....1 Set Fuse (500 mA, 5 mm dia. x 20 mm) ..1 PC
Optional Accessories & Adapters	Carrying case, Temperature Adapter, Light Adapter, Anemometer Adapter, Pressure Adapter, RH Adapter, Tachometer Adapter, High Voltage Probe.
* Ref. page 14	

2-2 Electrical Specifications (23 ± 5 °C)

Function	Range	Resolution	Accuracy	Overload Protection
DC/AC Voltage	400 mV (DC only)	0.1 mV	±(0.5 % + 2d)	 AC/DC 1000 V.
	4 V	0.001V	DCV:	
	40 V	0.01V	±(1 % + 2d)	
	400 V	0.1 V	ACV:	
	1000V	1 V	±(1.2 % + 5d)	
DC / AC Current (Direct input)	400 uA	0.1 uA	±(1.2% + 5d)	 AC/DC 500 mA (Fuse)
	4000 uA	1 uA		
	40 mA	0.01 mA		
	400 mA	0.1 mA		
DC / AC current (Clamp on)	400 A	0.1 A	±(2 % + 5 d)	 AC/DC 2000A/1000V
	2000 A	1 A	±(2 % + 8 d)	
Remark	* True rms measurement both for ACV, ACA function. * Input impedance for ACV & DCV range is 10 Mega ohm. * ACA, ACV frequency response is from 45 to 1 KHz. * ACA, ACV specification be tested on sine wave 50/60 Hz.			

Function	Range	Resolution	Accuracy	Overload Protection
Ohms	400 ohm	0.1 ohm	$\pm (1 \% + 5 d)$	 AC / DC 400V
	4 K ohm	1 ohm		
	40 K ohm	10 ohm		
	400 K ohm	100 ohm	$\pm (2 \% + 2 d)$	
	4 M ohm	1 K ohm		
	40 M ohm	10Kohm		
Capacitance	50 nF	10 pF	$\pm (3 \% + 5d)$ * See Remark	 AC / DC 400V
	500 nF	100 pF		
	5 uF	0.001 uF		
	50 uF	0.01 uF		
Frequency (> 5 V)	5 Hz	0.001 Hz	$\pm (1 \% + 5 d)$	 AC / DC 1000V
	50 Hz	0.01 Hz		
	500 Hz	0.1 Hz		
	5 KHz	1 Hz		
	50 KHz	0.01 KHz		
	100 KHz	0.1 KHz		
Duty cycle	1 % to 99 %	0.1 %		
Diode	Short/non conductance, good/defect test			
Continuity	If rmeasuring esistance is less than 10 ohm, the beeper will sound .			

Remark :

- * Spec. tested under the environment RF Field Strength less than 3 V/M & frequency less than the 30 MHz only.
- * The accuracy of capacitance range are specified under that the " zero " procedure is executed before the measurement (push " REL. button, refer 5-10, page 11).

3. FRONT PANEL DESCRIPTION

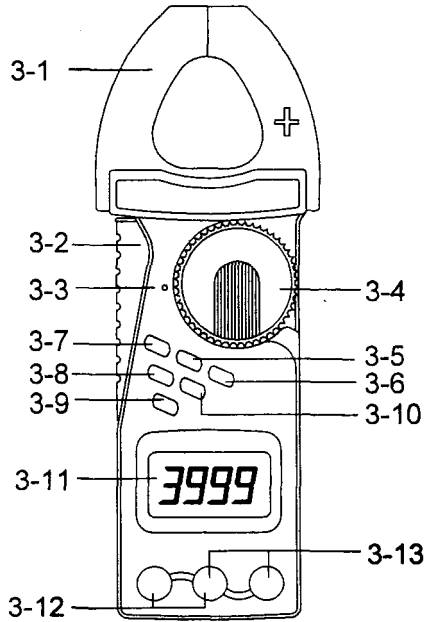

Fig. 1











- | | | | |
|-----|-------------------------------|------|---|
| 3-1 | Current Sense Jaws | 3-9 | Function button (DC/AC, ohm, Continuity, Diode Capacitance) |
| 3-2 | Trigger | 3-10 | Manual range select button |
| 3-3 | Function indicator | 3-11 | Display |
| 3-4 | Function rotary switch | 3-12 | uA/mA direct current input terminals |
| 3-5 | DCA zero button | 3-13 | V, ohm, Hz, Diode, Continuity, Capacitance input terminals |
| 3-6 | Relative button | | |
| 3-7 | Data hold / Back light button | | |
| 3-8 | V/Hz/% (Duty Cycle) button | | |

4. PRECAUTIONS & PREPARATIONS FOR MEASUREMENT

- 1) Ensure that the DC 9V battery is connected to its snap terminal with the right polarity and placed in the battery compartment correctly.
- 2) Place the Red & Black Test Leads into the proper input terminal before making measurement.
- 3) Remove either of the test leads from the circuit when changing the measurement range.
- 4) Except operate the " Data Hold " function, it should cancel the " Data Hold " function, otherwise the display reading will freeze permanently.
- 5) Do not exceed the maximum rated voltage to the input terminal.
- 6) Always switching the " Function Rotary Switch " to the " Off " position when the instrument is not operation.
- 7) Remove the battery if the instrument is not to be used in a long period of time.
- 8) Though the " Ohm " & " Capacitance " ranges build the overload protection circuit, however it is prohibited to apply any voltage to input terminal when making the measurement.
- 9) *The water resistance structure is apply for the front panel only. Do not throw the instrument into water, otherwise the meter will be damaged permanently.*
- 10) *For safety consideration, when change the new test leads, it should use the replace test leads that already approval of " CATIII-1000V ".*

5. MEASURING PROCEDURE

5-1 Symbols & units of display

Symbols / Units	Descriptions
	Appears when selecting DCV or DCA mode.
	Appears when selecting ACV & ACA mode.
	Appears when the " Data hold " function is operated.
	Appears when the " Relative " function is operated.
	Battery voltage is under the low condition already.
	Appears when operating the " Automatic range " mode.
	Appears when the " Continuity beeper " is operated.
mV, V	Units for voltage measurements.
Ω , K Ω , M Ω	Units for resistance measurements
	Appears when the " Diode " function is operated.
	Appears when measuring a DCV or DCA value is negative.
	Back light
%	Unit for " Duty cycle " measurement.
μ A, mA, A	Units for " Current " measurement.
Hz, KHz	Units for " Frequency " measurement.
nF, μ F	Units for " Capacitance " measurement.
	Appears when " Clamp on " current measurement is operated.

5-2 DCV, ACV Measurement

- 1) Connect BLACK test lead into " COM " terminal.
- 2) Connect RED test lead into " V " terminal.
- 3) If measure " DCV ", select the " Function rotary switch " (3-4, Fig. 1) to the " V " position then push the " FUNC. button " (3-9, Fig. 1) for display show " $\overline{\text{---}}$ ".
- 4) If measure " ACV ", select the " Function rotary switch " (3-4, Fig. 1) to the " V " position then push the " FUNC. button " (3-9, Fig. 1) for display show " \sim ".
- 5) When LCD show the " AUTO " marker, the meter is under the " auto range " mode., the meter will select the suitable measurement range automatically.
- 6) Under the operation of " auto range " mode, push the " Range button " (3-10 Fig. 1) will hold the range.

5-3 Resistance Measurement

- 1) Connect BLACK test lead into " COM " terminal.
- 2) Connect RED test lead into " Ω " terminal.
- 3) Select the " Function rotary switch " (3-4, Fig. 1) to the " Ω " position then push the " FUNC. button " (3-9, Fig. 1) for display show " Ω ".
- 4) When LCD show the " AUTO " marker, the meter is under the " auto range " mode., the meter will select the suitable measurement range automatically.
- 5) Under the operation of " auto range " mode, push the " Range button " (3-10 Fig. 1) will hold the range.

5-4 Continuity Check

- 1) Connect BLACK test lead into " COM " terminal.
- 2) Connect RED test lead into " Ω " terminal.
- 3) Select the " Function rotary switch " (3-4, Fig. 1) to the

- " \rightarrow " position then push the " FUNC. button " (3-9, Fig. 1) for display show " \rightarrow " .
- 4) when the resistance value is less than 10 ohm, the beeper sound will be generated.

5-5 Diode Test

- 1) Connect BLACK test lead into " COM " terminal.
- 2) Connect RED test lead into " \rightarrow " terminal.
- 3) Select the " Function rotary switch " (3-4, Fig. 1) to the " \rightarrow " position then push the " FUNC. button " (3-9, Fig. 1) for display show " \rightarrow " .
- 4) a. When connected with polarity as shown in Fig. 2, a forward current flow is established and the approx. Diode Forward Voltage (VF) value in volt will appears on the display reading. If the diode under test is defective, ".000 " or near ".000 " value (short circuit) or " 1 " (open circuit) will be displayed.

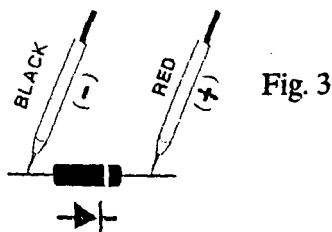
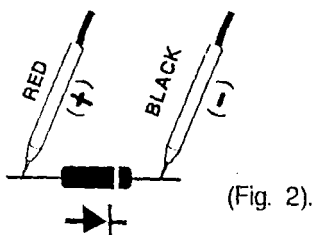

- b. When connected as shown in Fig. 3, a reverse check on the diode is made. If the diode under test is good, " 1 " will be displayed. If the diode under test is defective, ".000 " or other numbers will be displayed. Proper diode testing should include both steps a. and b. above.

5-6 AC Current Measurement (Clamp on)

- 1) Select the " Function rotary switch " (3-4, Fig. 1) to the " 2000A " position then push the " FUNC. button " (3-9, Fig. 1) for display show " \sim " .
- 2) Press the " Trigger " (3-2, fig. 1) to open the " Current Sensor Jaws " (3-1, Fig. 1) & clamp on the measure conductor only.

Consideration :

- a. Recommend use the "auto range "mode typically. However if push the " Range button " (3-10, Fig. 1) will hold the range.
- b. For safety reason, please insert the " Terminal rubber cover " (Fig. 4) for protection.



Fig. 4

5-7 DC Current Measurement (Clamp on)

- 1) Select the " Function rotary switch " (3-4, Fig. 1) to the " 2000A " position then push the " FUNC. button " (3-9, Fig. 1) for display show " --- " .
- 2) Push the " DCA zero button " (3-5, Fig. 1) at least 2 seconds to let the display show " ZERO " value.
- 3) Press the " Trigger " (3-2, fig. 1) to open the " Current Sensor Jaws " (3-1, Fig. 1) & clamp on the measure conductor only.

Consideration :

- a. Recommend use the "auto range "mode typically. However if push the " Range button " (3-10, Fig. 1) will hold the range.
- b. For safety reason, please insert the " Terminal rubber cover " (Fig. 4) for protection.

5-8 AC Current measurement (Direct input)

- 1) Connect BLACK test lead into " COM " terminal.
- 2) Connect RED test lead into " uA, mA " terminal.
- 3) If measure " uA " (400 uA, 4000 uA), select the " Function rotary switch " (3-4, Fig. 1) to the " uA " position then push the " FUNC. button " (3-9, Fig. 1) for display show " \sim " .
- 4) If measure " mA " (40 mA, 400 mA), select the " Function rotary switch " (3-4, Fig. 1) to the " mA " position then push the " FUNC. button " (3-9, Fig. 1) for display show " \sim " .
- 5) Open the circuit in which the current are to be measured.
Now securely connect test lead in series with the circuit.

5-9 DC Current measurement (Direct input)

All the measuring procedures are same as above 5-8, except push the " FUNC. button " (3-9, Fig. 1) for display show " \equiv " .

Consideration :

- a. **The max. reading value for direct input current value is AC/DC 400 mA . Do not exceed the input current value more than 400 mA. Otherwise the protection fuse will be broken.**
- b. **For the direct current input, after input the current, the meter is out of function (show 0). Then please check if the protection fuse (500 mA) is already broken or not ? Detail please refer " 6-2 Replacement of fuse " .**

5-10 Capacitance Measurement

- 1) Connect BLACK test lead into " COM " terminal.
- 2) Connect RED test lead into " + " terminal.
- 3) Select the " Function rotary switch " (3-4, Fig. 1) to the " + " position then push the " Function button " (3-9, Fig. 1) for display show " nF "
- 4) **Zero adjustment :**
Due to the consideration of the existing " stray capacitance " of the internal circuit board or the test alligator. For the 50 nF & 500 nF range, it should to make the zero adjustment procedures before make the measurement first. Open the input terminal & not connecting the measured capacitor, push the " REL. Button " (3-6, Fig. 1), the display will show zero value. Then connect the measuring capacitor again & make the measurement following.
- 5) For the capacitance measurement, the meter is always under the " auto range " mode., it will select the suitable measurement range automatically.

5-11 Frequency Measurement

- 1) Connect BLACK test lead into " COM " terminal.
- 2) Connect RED test lead into " Hz " terminal.
- 3) Select the " Function rotary switch " (3-4, Fig. 1) to the " Hz " position then push the " Hz/% button " (3-8, Fig. 1) for display show " Hz " .
- 4) For the FREQUENCY measurement, the meter is always under the " auto range " mode, it will select the suitable measurement range automatically.

5-12 Duty Cycle Measurement

All the measuring procedures are same as above 5-11 (Frequency measurement) except push the " Hz/% " (3-8, Fig. 1) for display show " % ".

5-13 Data Hold Operation

- 1) During the measurement, pushing the " Hold button " (3-7, Fig. 1) once a while will freeze the measured value & the LCD will indicate " H " symbol.
- 2) Push the " Hold Button " again to release the data hold function.

5-14 Relative Operation

- 1) During the measurement, the circuit will memorize the last measured values if push the " REL. Button " (3-6, Fig. 1) at once, then LCD will show zero value & a " REL " indicator.
- 2) The input measured values will deduct last measured values " automatically, then show those new value on the display.
- 3) It will release the Relative Measurement function if push the REL. button at once again, at same time the " REL " marker will disappear.

5-15 Back light Operation

- 1) Push the "  button " (3-7, Fig. 1) about two seconds continuously, the LCD back light lamp will turn on.

6. MAINTENANCE

6-1 Replacement of Battery



Caution : Remove test leads before open the battery cover !

- 1) When the LCD display shows "  ". It is necessary to replace the battery, However in-spec. measurement may still be made for several hours after " Low battery indicator " appears before the instrument become inaccurate.
- 2) Open the screw of " Battery Cover " by screwdriver, then move the battery.
- 3) Replace with 9V battery and reinstate the cover.

6-2 Replacement of Fuse

Fuse :

Rating : 500 mA, Size : 5 mm dia. x 20 mm

- 1) The meter is provided with one 5 x 20 mm 500 mA fuse for current (direct input) measurement. current range overload protection purpose.
- 2) When the direct input current range can not operate, please check if the fuse is broken ?
When replace the fuse, open the housing case and remove the fuse from the main PC board.
- 3) Replace the fuse according the spec. and reinstate the housing case again.

6-3 Cleaning



Caution : *Cleaning – Only use the dry cloth to clean the plastic case !*

7. OPTIONAL ACCESSORIES & ADAPTERS

<i>Items</i>	<i>Model</i>
<i>Carry case</i>	<i>CA-05A</i>
<i>Humidity Adapter</i>	<i>HA-702</i>
<i>Light Adapter</i>	<i>LX-02</i>
<i>EMF Adapter</i>	<i>EMF-824</i>
<i>Pressure Adapter</i>	<i>PS-403</i>
<i>Anemometer Adapter</i>	<i>AM-402</i>
<i>Tachometer Adapter</i>	<i>TA-601</i>
<i>Sound Adapter</i>	<i>SL-406</i>
<i>High Voltage Probe</i>	<i>HV-40</i>
<i>Test lead with alligator clips</i>	<i>TL-02AS</i>